



# Cross-Roller Ring Series

---

Compact, Highly Rigid Swivel Bearings  
Achieving a Superb Rotation Accuracy



● For details, visit THK at [www.thk.com](http://www.thk.com) ●  
\*Product information is updated regularly on the THK website.

# Contents

## ▼Cross-Roller Ring Series

Structure and Features .....	P.2-3
Types and Features .....	P.4
Selection.....	P.5
Rated Life .....	P.5
Static Safety Factor .....	P.6
Static Permissible Moment.....	P.6
Static Permissible Axial Load .....	P.6
Accuracy Standards.....	P.7-
Radial Clearance .....	P.12
Fit .....	P.13
Designing the Housing and the Presser Flange ....	P.14-15
Installation Procedure.....	P.15
Examples of Model Number Coding .....	P.16
Dimensional Tables <b>Model RU</b> .....	P.17-18
<b>Model RB</b> .....	P.19-20
<b>Model RE</b> .....	P.21-23
USP Grade Series of Models RB/RE ....	P.24
<b>Model RA</b> .....	P.25-26



# Cross-Roller Ring

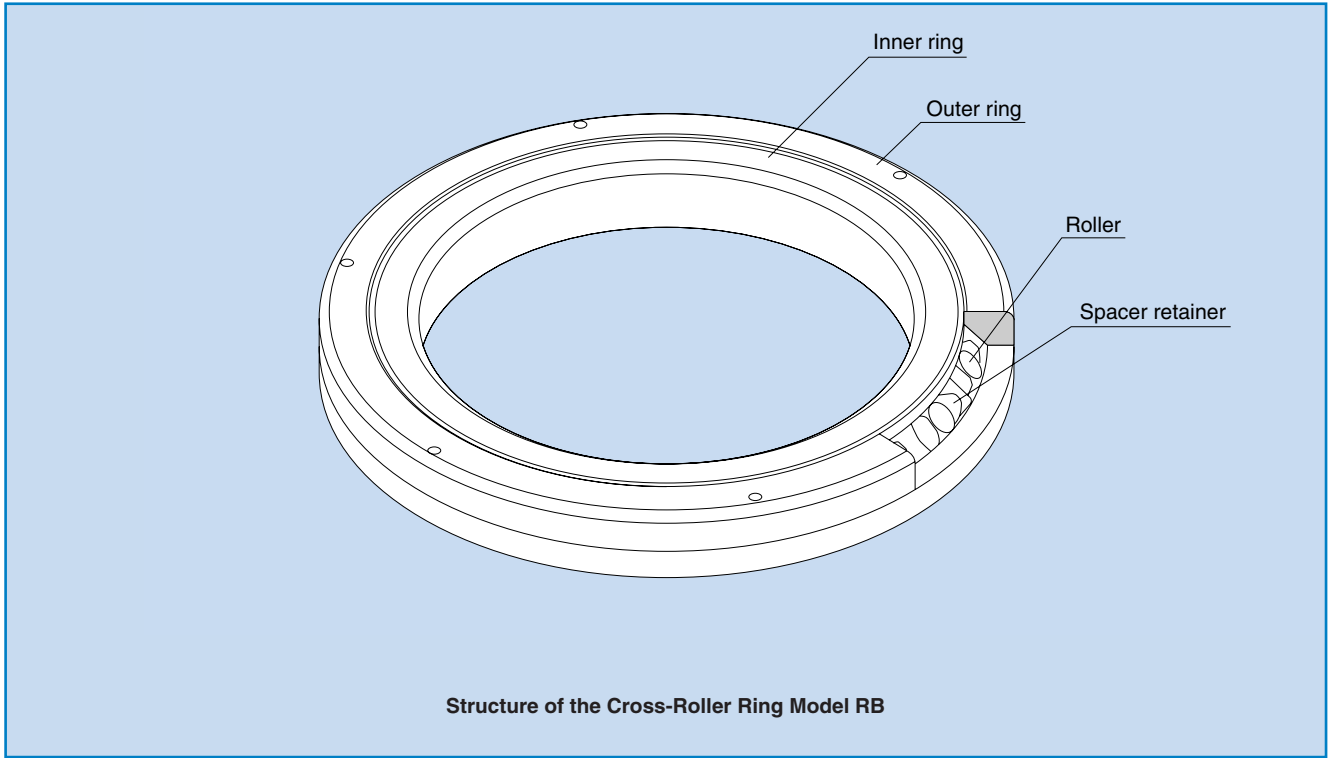

With the Cross-Roller Ring, cylindrical rollers are arranged crosswise, with each roller perpendicular to the adjacent roller, in a 90° V groove, separated from each other by a spacer retainer. This design allows just one bearing to receive loads in all directions including, radial, axial and moment loads. Since the Cross-Roller Ring achieves high rigidity despite the minimum possible dimensions of the inner and outer rings, it is optimal for applications such as joints and swiveling units of industrial robots, swiveling tables of machining centers, rotary units of manipulators, precision rotary tables, medical equipment, measuring instruments and IC manufacturing machines.

## ● High Rotation Accuracy

The spacer retainer fitting among cross-arrayed rollers prevents rollers from skewing and the rotation torque from increasing due to friction between rollers. Unlike conventional types using steel sheet retainers, the Cross-Roller Ring does not cause displacement or locking of rollers and provides a stable rotation torque.

Since the inner and outer rings are designed to be separable, the bearing clearance can be adjusted. In addition, highly accurate rotary motion is ensured through adjusting the bearing clearance to provide a preload.

## ● Easy Handling

The inner and outer rings, which are separable, are secured to the Cross-Roller Ring body after the rollers and spacer retainers are installed. This procedure prevents the rings from separating from each other. Thus, it is easy to handle the rings when installing the Cross-Roller Ring.

## ● Skewing Prevention

The spacer retainer keeps rollers in their proper position, thereby preventing them from skewing. This eliminates friction between rollers, and therefore secures a stable rotation torque.

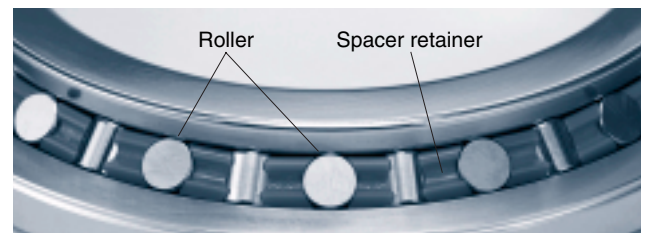

## ● Significantly Increased Rigidity (Three to Four times Greater)

Unlike the thin angular ball bearings installed in double rows, the cross array of rollers allows a single Cross-Roller Ring unit to receive loads in all directions, increasing the rigidity to three to four times greater than the conventional type.

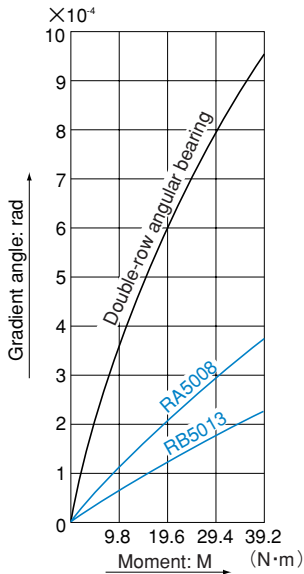

Moment Rigidity Diagram

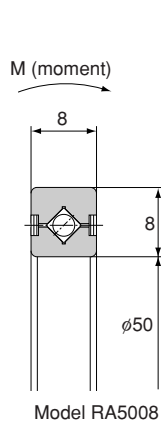

Model RA5008

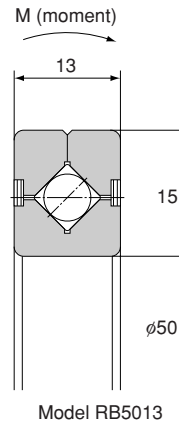

Model RB5013

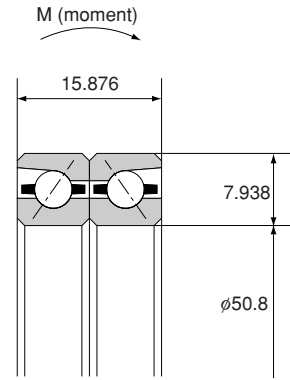

Angular ball bearing

Cross-Roller Ring

## ● Large Load Capacity

(1) Compared with the conventional steel sheet retainers, the spacer retainer allows a longer effective contact length of each roller, thus significantly increasing the load capacity.

The spacer retainer guides rollers by holding them over the entire length of each roller, whereas the conventional type of retainer supports them only at a point in the center of each roller. Such one-point contact cannot sufficiently prevent skewing.

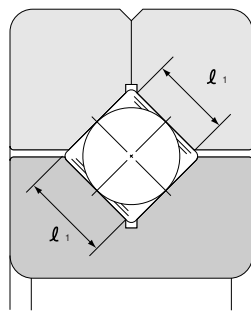

With a spacer retainer

Roller contact length  
 $l_1 > l_2$

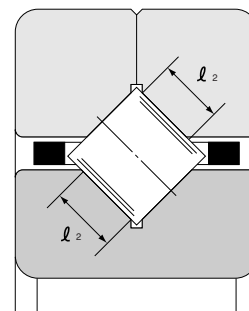

With a steel sheet retainer (conventional type)

(2) In conventional types, the loaded areas are asymmetrical between the outer-ring and the inner-ring sides around the roller longitudinal axis. The greater the applied load, the greater the moment becomes, thus causing end-face contact to occur. This creates frictional resistance, which hinders smooth rotation and quickens wear.

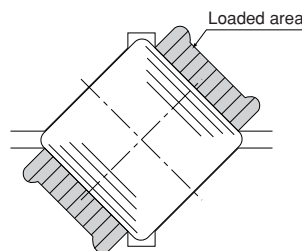

Symmetrical loaded areas  
Design with a spacer retainer

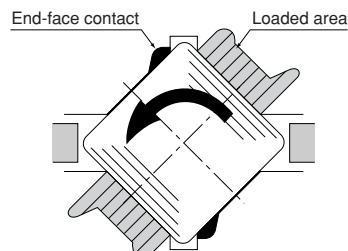

Asymmetrical loaded areas  
Design with a steel sheet retainer (conventional type)

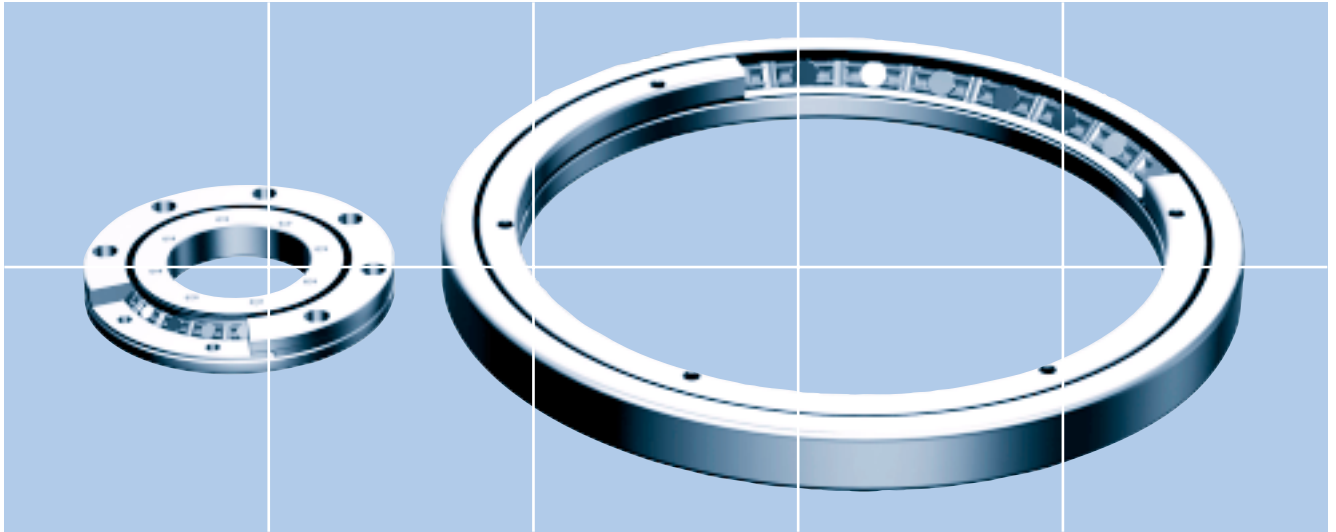

# Cross-Roller Ring Outline

## Cross-Roller Ring Product Overview

### Model RU (Integrated Inner/Outer Ring Type)

Since the mounting holes are provided, this model does not require a presser flange or housing. In addition, because it has an integrated inner/outer ring structure and is equipped with washers, its performance is minimally affected by the mounting procedure, ensuring stable rotation accuracy and torque. This model can be used for both inner-ring rotation and outer-ring rotation.

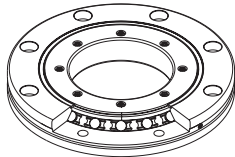

### Model RE (Separable Inner Ring Type for Outer Ring Rotation)

Having the same major dimensions as model RB, this model is used in locations where the rotation accuracy of the outer ring is required.

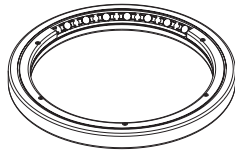

### Model RA (Separable Outer Ring Type for Inner Ring Rotation)

Based on model RB, this model is a light and compact type with the thinnest possible inner and outer rings. It is optimal for locations where weight reduction and downsizing are required, such as the hand swiveling unit of robots and manipulators.

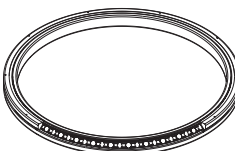

### Model RB (Separable Outer Ring Type for Inner Ring Rotation)

Being the basic model of the Cross-Roller Ring, its outer ring is separable while the inner ring is integrated with the main body. This model is used in locations where the rotation accuracy of the inner ring is required. Major applications include the index table swiveling unit of machine tools.

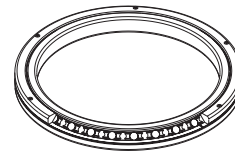

### USP-Grade Series of Models RB/RE

The rotation accuracy of the USP-Grade Series achieves the ultra precision grade that surpasses the world's highest accuracy standards, such as JIS Class 2, ISO Class 2, DIN P2 and AFBMA ABEC9.

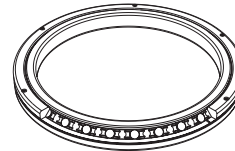

### Model RA-C (Single-Split Type)

The major dimensions of this model are the same as that of model RA. Since the outer ring is split at one point to increase the rigidity of the outer ring, this model can also be used for outer ring rotation.

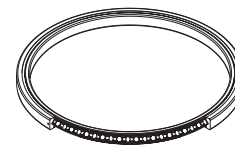

# Selection of a Cross-Roller Ring

The following diagram shows a typical procedure for selecting a Cross-Roller Ring.

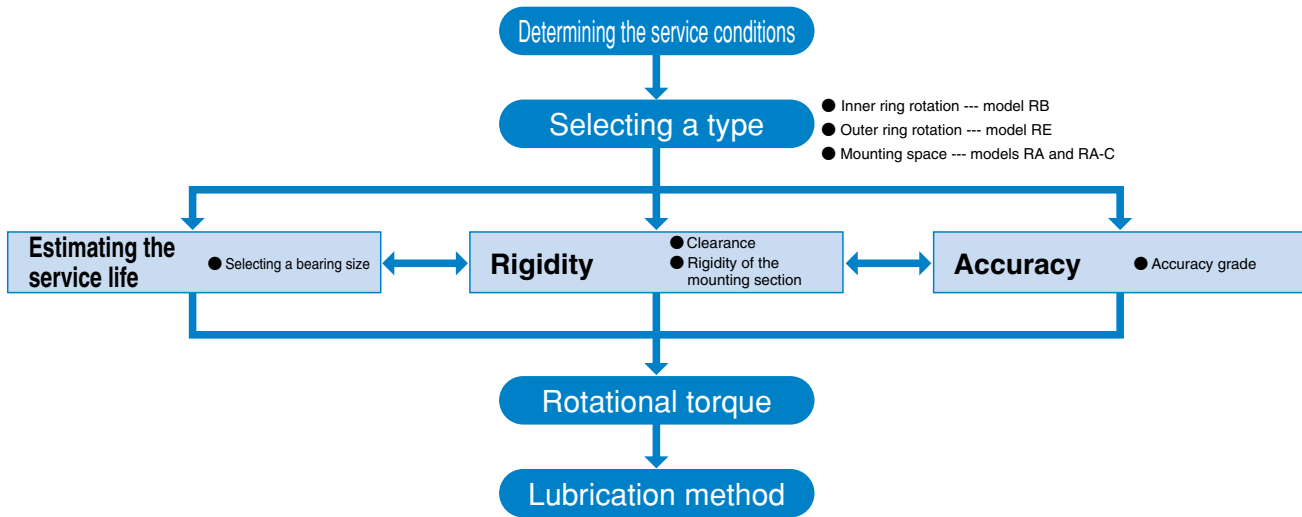

## Rated Life

The service life of a Cross-Roller Ring is obtained from the following equation.

$$L = \left( \frac{f_r \cdot C}{f_w \cdot P_c} \right)^{\frac{10}{3}} \times 10^6$$

- L : Rated life
- C : Basic dynamic load rating\* (N)
- P<sub>c</sub> : Dynamic equivalent radial load (N)
- f<sub>r</sub> : Temperature factor (see Fig. 1)
- f<sub>w</sub> : Load factor (see Table 1)

\*Note: The basic dynamic load rating (C) of the Cross-Roller Ring indicates the radial load with constant direction and magnitude, under which the rated life (L) is 1 million revolutions when a group of identical Cross-Roller Ring units independently operate under the same conditions. The basic dynamic load rating (C) is indicated in the dimensional table.

### [Dynamic equivalent radial load P<sub>c</sub>]

The dynamic equivalent radial load of the Cross-Roller Ring is obtained from the following equation.

$$P_c = X \cdot \left( F_r + \frac{2M}{dp} \right) + Y \cdot F_a$$

- P<sub>c</sub> : Dynamic equivalent radial load (N)
- F<sub>r</sub> : Radial load (N)
- F<sub>a</sub> : Axial load (N)
- M : Moment (N-mm)
- X : Dynamic radial factor (see Table 2)
- Y : Dynamic axial factor (see Table 2)
- dp : Roller pitch circle diameter (mm)

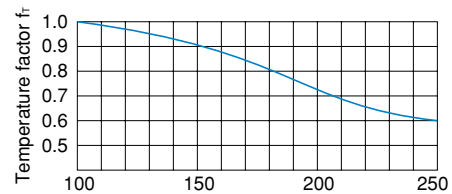

Fig. 1 Temperature Factor (f<sub>r</sub>)

Note: The normal service temperature is 80°C or below. If the product is to be used at a higher temperature, contact THK.

Table 1 Load Factor (f<sub>w</sub>)

Service condition	f <sub>w</sub>
Smooth motion without impact	1 to 1.2
Normal motion	1.2 to 1.5
Motion with severe impact	1.5 to 3

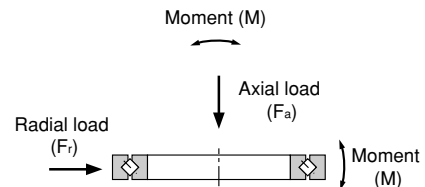

Fig. 2

Table 2 Dynamic Radial Factor and Dynamic Axial Factor

Classification	X	Y
$\frac{F_a}{F_r + 2M/dp} \leq 1.5$	1	0.45
$\frac{F_a}{F_r + 2M/dp} > 1.5$	0.67	0.67

- If F<sub>r</sub> = 0 N and M = 0 N-mm, perform calculation assuming that X = 0.67 and Y = 0.67.
- For service life calculation with a preload taken into account, contact THK.

### Static Safety Factor

The basic static load rating  $C_0$  refers to the static load with constant direction and magnitude, under which the calculated contact stress in the center of the contact area between the roller and the raceway where the maximum load is applied is 4,000 MPa (if the deformation exceeds this level, it will affect the rotation). This value is indicated as  $C_0$  in the dimensional table. When a load is statically or dynamically applied, it is necessary to consider the static safety factor as shown below.

$$\frac{C_0}{P_0} = f_s$$

- $f_s$  : Static safety factor (see Table 3)
- $C_0$  : Basic static load rating (N)
- $P_0$  : Static equivalent radial load (N)

Table 3 Static Safety Factor ( $f_s$ )

Load conditions	Lower limit of $f_s$
Normal load	1 to 2
Impact load	2 to 3

### [Static Equivalent Radial Load $P_0$ ]

The static equivalent radial load of the Cross-Roller Ring is obtained from the following equation.

$$P_0 = X_0 \cdot \left( F_r + \frac{2M}{dp} \right) + Y_0 \cdot F_a$$

- $P_0$  : Static equivalent radial load (N)
- $F_r$  : Radial load (N)
- $F_a$  : Axial load (N)
- $M$  : Moment (N-mm)
- $X_0$  : Static radial factor ( $X_0 = 1$ )
- $Y_0$  : Static axial factor ( $Y_0 = 0.44$ )
- $dp$  : Roller pitch circle diameter (mm)

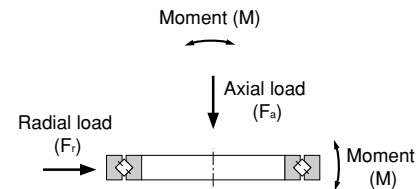

Fig. 4

### Static Permissible Moment

The static permissible moment ( $M_0$ ) of the Cross-Roller Ring is obtained from the following equation.

$$M_0 = C_0 \cdot \frac{dp}{2} \times 10^{-3}$$

- $M_0$  : Static permissible moment (kN-m)
- $C_0$  : Basic static load rating (kN)
- $dp$  : Roller pitch circle diameter (mm)

### Static Permissible Axial Load

The static permissible axial load ( $F_{a0}$ ) of the Cross-Roller Ring is obtained from the following equation.

$$F_{a0} = \frac{C_0}{Y_0}$$

- $F_{a0}$  : Static permissible axial load (kN)
- $Y_0$  : Static axial factor ( $Y_0 = 0.44$ )

# Accuracy Standards

The Cross-Roller Ring is manufactured with the accuracy and the dimensional tolerance showing in the Tables 4 to 13.

Table 4 Rotation Accuracy of the Inner Ring of Model RU

Unit:  $\mu\text{m}$

Model number	Radial runout tolerance of the inner ring			Axial runout tolerance of the inner ring		
	Grade P5	Grade P4	Grade P2	Grade P5	Grade P4	Grade P2
RU 42	4	3	2.5	4	3	2.5
RU 66	5	4	2.5	5	4	2.5
RU 85	5	4	2.5	5	4	2.5
RU124	5	4	2.5	5	4	2.5
RU148	6	5	2.5	6	5	2.5
RU178	6	5	2.5	6	5	2.5
RU228	8	6	5	8	6	5
RU297	10	8	5	10	8	5
RU445	15	12	7	15	12	7

Note: The standard rotation accuracy of model RU is grade P5 (not expressed in the model number).

Table 5 Rotation Accuracy of the Outer Ring of Model RU

Unit:  $\mu\text{m}$

Model number	Radial runout tolerance of the outer ring			Axial runout tolerance of the outer ring		
	Grade P5	Grade P4	Grade P2	Grade P5	Grade P4	Grade P2
RU 42	8	5	4	8	5	4
RU 66	10	6	5	10	6	5
RU 85	10	6	5	10	6	5
RU124	13	8	5	13	8	5
RU148	15	10	7	15	10	7
RU178	15	10	7	15	10	7
RU228	18	11	7	18	11	7
RU297	20	13	8	20	13	8
RU445	25	16	10	25	16	10

Note: The standard rotation accuracy of model RU is grade P5 (not expressed in the model number).



# CROSS ROLLER RING OUTLINE

## Cross-Roller Ring Product Overview

Table 6 Rotation Accuracy of the Inner Ring of Model RB

Unit:  $\mu\text{m}$

Nominal dimension of the bearing inner diameter (d) (mm)		Radial runout tolerance of the inner ring					Axial runout tolerance of the inner ring				
		Grade 0	Grade PE6	Grade PE5	Grade PE4	Grade PE2	Grade 0	Grade PE6	Grade PE5	Grade PE4	Grade PE2
			Grade P6	Grade P5	Grade P4	Grade P2		Grade P6	Grade P5	Grade P4	Grade P2
Above	Or less										
18	30	13	8	4	3	2.5	13	8	4	3	2.5
30	50	15	10	5	4	2.5	15	10	5	4	2.5
50	80	20	10	5	4	2.5	20	10	5	4	2.5
80	120	25	13	6	5	2.5	25	13	6	5	2.5
120	150	30	18	8	6	2.5	30	18	8	6	2.5
150	180	30	18	8	6	5	30	18	8	6	5
180	250	40	20	10	8	5	40	20	10	8	5
250	315	50	25	13	10	—	50	25	13	10	—
315	400	60	30	15	12	—	60	30	15	12	—
400	500	65	35	18	14	—	65	35	18	14	—
500	630	70	40	20	16	—	70	40	20	16	—
630	800	80	—	—	—	—	80	—	—	—	—
800	1000	90	—	—	—	—	90	—	—	—	—
1000	1250	100	—	—	—	—	100	—	—	—	—

Table 7 Rotation Accuracy of the Outer Ring of Model RE

Unit:  $\mu\text{m}$

Nominal dimension of the bearing outer diameter (D) (mm)		Radial runout tolerance of the outer ring					Axial runout tolerance of the outer ring				
		Grade 0	Grade PE6	Grade PE5	Grade PE4	Grade PE2	Grade 0	Grade PE6	Grade PE5	Grade PE4	Grade PE2
			Grade P6	Grade P5	Grade P4	Grade P2		Grade P6	Grade P5	Grade P4	Grade P2
Above	Or less										
30	50	20	10	7	5	2.5	20	10	7	5	2.5
50	80	25	13	8	5	4	25	13	8	5	4
80	120	35	18	10	6	5	35	18	10	6	5
120	150	40	20	11	7	5	40	20	11	7	5
150	180	45	23	13	8	5	45	23	13	8	5
180	250	50	25	15	10	7	50	25	15	10	7
250	315	60	30	18	11	7	60	30	18	11	7
315	400	70	35	20	13	8	70	35	20	13	8
400	500	80	40	23	15	—	80	40	23	15	—
500	630	100	50	25	16	—	100	50	25	16	—
630	800	120	60	30	20	—	120	60	30	20	—
800	1000	120	75	—	—	—	120	75	—	—	—
1000	1250	120	—	—	—	—	120	—	—	—	—
1250	1600	120	—	—	—	—	120	—	—	—	—

Table 8 Rotation Accuracy of the Inner Ring of Models RA and RA-C Unit:  $\mu\text{m}$

Nominal dimension of the bearing inner diameter (d) (mm)		Tolerance in radial/axial runout
Above	Or less	
40	65	13
65	80	15
80	100	15
100	120	20
120	140	25
140	180	25
180	200	30

Note: If higher accuracy than the above values is required for the inner ring in rotation accuracy for models RA and RA-C, contact THK.

Table 9 Rotation Accuracy of the Outer Ring of Model RA-C Unit:  $\mu\text{m}$

Nominal dimension of the bearing outer diameter (D) (mm)		Tolerance in radial/axial runout
Above	Or less	
65	80	13
80	100	15
100	120	15
120	140	20
140	180	25
180	200	25
200	250	30

Note: The rotation accuracy of the outer ring for model RA-C indicates the value before separation.

Table 10 Dimensional Tolerance of the Bearing Inner Diameter

Unit:  $\mu\text{m}$ 

Nominal dimension of the bearing inner diameter (d) (mm)		Tolerance of dm <small>(see Note 2)</small>							
		Grades 0, P6, P5, P4 and P2		Grade PE6		Grade PE5		Grades PE4 and PE2	
Above	Or less	Upper	Lower	Upper	Lower	Upper	Lower	Upper	Lower
18	30	0	-10	0	-8	0	-6	0	-5
30	50	0	-12	0	-10	0	-8	0	-6
50	80	0	-15	0	-12	0	-9	0	-7
80	120	0	-20	0	-15	0	-10	0	-8
120	150	0	-25	0	-18	0	-13	0	-10
150	180	0	-25	0	-18	0	-13	0	-10
180	250	0	-30	0	-22	0	-15	0	-12
250	315	0	-35	0	-25	0	-18	—	—
315	400	0	-40	0	-30	0	-23	—	—
400	500	0	-45	0	-35	—	—	—	—
500	630	0	-50	0	-40	—	—	—	—
630	800	0	-75	—	—	—	—	—	—
800	1000	0	-100	—	—	—	—	—	—
1000	1250	0	-125	—	—	—	—	—	—

Note 1: The standard inner diameter accuracy of models RA, RA-C and RU is grade 0. For higher accuracy than grade 0, contact THK.

Note 2: "dm" represents the arithmetic average of the maximum and minimum diameters obtained in measuring the bearing inner diameter at two points.

Note 3: For accuracy grades of the bearing inner diameter with no values indicated in the table, the highest value among the low accuracy grades applies.

Table 11 Dimensional Tolerance of the Bearing Outer Diameter

Unit:  $\mu\text{m}$ 

Nominal dimension of the bearing outer diameter (D) (mm)		Tolerance of Dm <small>(see Note 2)</small>							
		Grades 0, P6, P5, P4 and P2		Grade PE6		Grade PE5		Grades PE4 and PE2	
Above	Or less	Upper	Lower	Upper	Lower	Upper	Lower	Upper	Lower
30	50	0	-11	0	-9	0	-7	0	-6
50	80	0	-13	0	-11	0	-9	0	-7
80	120	0	-15	0	-13	0	-10	0	-8
120	150	0	-18	0	-15	0	-11	0	-9
150	180	0	-25	0	-18	0	-13	0	-10
180	250	0	-30	0	-20	0	-15	0	-11
250	315	0	-35	0	-25	0	-18	0	-13
315	400	0	-40	0	-28	0	-20	0	-15
400	500	0	-45	0	-33	0	-23	—	—
500	630	0	-50	0	-38	0	-28	—	—
630	800	0	-75	0	-45	0	-35	—	—
800	1000	0	-100	—	—	—	—	—	—
1000	1250	0	-125	—	—	—	—	—	—
1250	1600	0	-160	—	—	—	—	—	—

Note 1: The standard outer diameter accuracy of models RA, RA-C and RU is grade 0. For higher accuracy than grade 0, contact THK.

Note 2: "Dm" represents the arithmetic average of the maximum and minimum diameters obtained in measuring the bearing outer diameter at two points.

Note 3: For accuracy grades of the bearing outer diameter with no values indicated in the table, the highest value among the low accuracy grades applies.

# CROSS ROLLER RING OUTLINE

## Cross-Roller Ring Product Overview

Table 12 Tolerance of the Inner/Outer Ring Width of Model RU Unit:  $\mu\text{m}$

Model number	Tolerance of B	
	Upper	Lower
RU 42	0	-75
RU 66	0	-75
RU 85	0	-75
RU124	0	-75
RU148	0	-75
RU178	0	-100
RU228	0	-100
RU297	0	-100
RU445	0	-150

Table 13 Tolerance of the Inner/Outer Ring Width of Models RB and RE (Common to All Grades)

Unit:  $\mu\text{m}$

Nominal dimension of the bearing inner diameter (d) (mm)		Tolerance of B		Tolerance of B1	
		Applied to the inner ring of model RB and the outer ring of model RE		Applied to the outer ring of model RB and the inner ring of model RE	
Above	Or less	Upper	Lower	Upper	Lower
18	30	0	-75	0	-100
30	50	0	-75	0	-100
50	80	0	-75	0	-100
80	120	0	-75	0	-100
120	150	0	-100	0	-120
150	180	0	-100	0	-120
180	250	0	-100	0	-120
250	315	0	-120	0	-150
315	400	0	-150	0	-200
400	500	0	-150	0	-200
500	630	0	-150	0	-200
630	800	0	-150	0	-200
800	1000	0	-300	0	-400
1000	1250	0	-300	0	-400

Note: All B and B1 steps of models RA and RA-C are manufactured with tolerance between -0.120 and 0.

# Accuracy Standards for the USP Series

## [Example of Rotation Accuracy of the USP Series]

The rotation accuracy of the USP-Grade Series achieves the ultra precision grade that surpasses the world's highest accuracy standards, such as JIS Class 2, ISO Class 2, DIN P2 and AFBMA ABEC9.

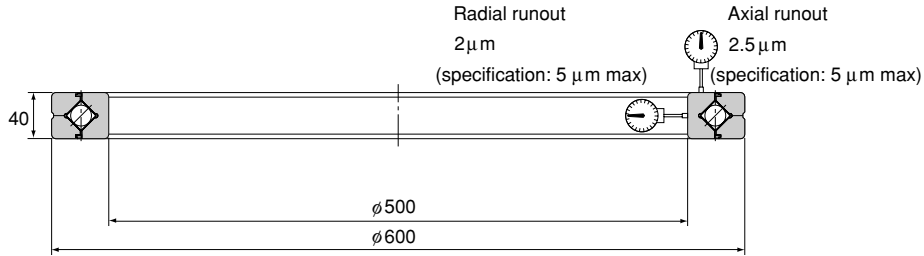

Rotation accuracy of the inner ring of model RB50040CC0USP

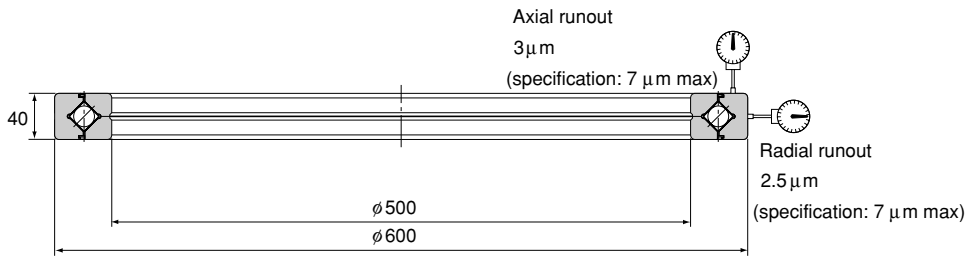

Rotation accuracy of the outer ring of model RE50040CC0USP

## [Accuracy Standards for the USP Series]

The USP-Grade Series of the Cross-Roller Ring models RU, RB and RE are manufactured with the accuracy and the dimensional tolerance showing in Tables 14 and 15.

Table 14 Runout Accuracy of the USP-Grade Series of Models RB and RE Unit:  $\mu\text{m}$

Nominal dimension of the inner diameter (d) and outer diameter (D) (mm)		Runout accuracy of the inner ring of model RB		Runout accuracy of the outer ring of model RE	
Above	Or less	Radial runout tolerance	Axial runout tolerance	Radial runout tolerance	Axial runout tolerance
80	180	2.5	2.5	3	3
180	250	3	3	4	4
250	315	4	4	4	4
315	400	4	4	5	5
400	500	5	5	5	5
500	630	6	6	7	7
630	800	—	—	8	8

Table 15 Runout Accuracy of the USP-Grade Series of Model RU Unit:  $\mu\text{m}$

Model number	Runout accuracy of the inner ring of model RU		Runout accuracy of the outer ring of model RU	
	Radial runout tolerance	Axial runout tolerance	Radial runout tolerance	Axial runout tolerance
RU 42	2	2	3	3
RU 66	2	2	3	3
RU 85	2	2	3	3
RU124	2	2	3	3
RU148	2	2	4	4
RU178	2	2	4	4
RU228	2.5	2.5	4	4
RU297	3	3	5	5
RU445	4	4	7	7

### Radial Clearance

Tables 16, 17, 18 and 19 show the radial clearance of model RU, the standard type of models RB/RE, the USP-Grade Series of models RB/RE, and models RA/RA-C (thin type), respectively.

Table 16 Radial Clearance of Model RU Unit:  $\mu\text{m}$

Model number	CC0		C0	
	Starting torque [N·m]		Radial clearance [ $\mu\text{m}$ ]	
	Min.	Max.	Min.	Max.
RU 42	0.1	0.5	0	25
RU 66	0.3	2.2	0	30
RU 85	0.4	3	0	40
RU124	1	6	0	40
RU148	1	10	0	40
RU178	3	15	0	50
RU228	5	20	0	60
RU297	10	35	0	70
RU445	20	55	0	100

Note: Clearance CC0 of model RU is expressed in starting torque. The starting torque value for clearance CC0 does not include a seal resistance.

Table 18 Radial Clearance of the USP-Grade Series of Models RB and RE Unit:  $\mu\text{m}$

Roller pitch circle diameter (dp) (mm)		CC0		C0	
Above	Or less	Min.	Max.	Min.	Max.
120	160	-10	0	0	40
160	200	-10	0	0	50
200	250	-10	0	0	60
250	280	-15	0	0	80
280	315	-15	0	0	100
315	355	-15	0	0	110
355	400	-15	0	0	120
400	500	-20	0	0	130
500	560	-20	0	0	150
560	630	-20	0	0	170
630	710	-20	0	0	190

Table 17 Radial Clearance of Models RB and RE Unit:  $\mu\text{m}$

Roller pitch circle diameter (dp) (mm)		CC0		C0		C1	
Above	Or less	Min.	Max.	Min.	Max.	Min.	Max.
18	30	-8	0	0	15	15	35
30	50	-8	0	0	25	25	50
50	80	-10	0	0	30	30	60
80	120	-10	0	0	40	40	70
120	140	-10	0	0	40	40	80
140	160	-10	0	0	40	40	90
160	180	-10	0	0	50	50	100
180	200	-10	0	0	50	50	110
200	225	-10	0	0	60	60	120
225	250	-10	0	0	60	60	130
250	280	-15	0	0	80	80	150
280	315	-15	0	30	100	100	170
315	355	-15	0	30	110	110	190
355	400	-15	0	30	120	120	210
400	450	-20	0	30	130	130	230
450	500	-20	0	30	130	130	250
500	560	-20	0	30	150	150	280
560	630	-20	0	40	170	170	310
630	710	-20	0	40	190	190	350
710	800	-30	0	40	210	210	390
800	900	-30	0	40	230	230	430
900	1000	-30	0	50	260	260	480
1000	1120	-30	0	60	290	290	530
1120	1250	-30	0	60	320	320	580
1250	1400	-30	0	70	350	350	630

Table 19 Radial Clearance of Models RA and RA-C Unit:  $\mu\text{m}$

Roller pitch circle diameter (dp) (mm)		CC0		C0	
Above	Or less	Min.	Max.	Min.	Max.
50	80	-8	0	0	15
80	120	-8	0	0	15
120	140	-8	0	0	15
140	160	-8	0	0	15
160	180	-10	0	0	20
180	200	-10	0	0	20
200	225	-10	0	0	20

### [Fit for Model RU]

Model RU does not require a fit in principle. However, if a certain level of positioning accuracy is required, h7 and H7 are recommended for the fit.

### [Fit for Models RB, RE and RA]

For the fit for models RB, RE and RA, we recommend using the combinations indicated in Table 20.

Table 20 Fit for Models RB, RE and RA

Radial clearance	Service conditions		Shaft	Housing
C0	Inner ring rotational load	Normal load	h5	H7
		Large impact/moment	h5	H7
	Outer ring rotational load	Normal load	g5	Js7
		Large impact/moment	g5	Js7
C1	Inner ring rotational load	Normal load	j5	H7
		Large impact/moment	k5	Js7
	Outer ring rotational load	Normal load	g6	Js7
		Large impact/moment	h5	K7

Note: For the fit for clearance CC0, avoid an interference because it will cause an excessive preload. As for the fit when you have selected clearance CC0 for the joints or swiveling unit of a robot, the combination of g5 and H7 is recommended.

### [Fit for the USP-Grade Series]

For the fit for the USP-Grade Series of models RB and RE, we recommend using the combinations indicated in Table 21.

Table 21 Fit for the USP-Grade Series

Radial clearance	Service conditions	Shaft	Housing
CC0	Inner ring rotational load	h5	J7
	Outer ring rotational load	g5	Js7
C0	Inner ring rotational load	j5	J7
	Outer ring rotational load	g5	K7

Note: We recommend measuring the inner and outer diameters of the bearing and selecting a slight interference fit that corresponds to the measurement.

### [Fit for Model RA-C]

For the fit for model RA-C, we recommend using the combinations indicated in Table 22.

Table 22 Fit for Model RA-C

Radial clearance	Service conditions	Shaft	Housing
CC0	Inner ring rotational load	h5	J7
	Outer ring rotational load	g5	Js7
C0	Inner ring rotational load	j5	J7
	Outer ring rotational load	g5	K7

### ● Designing the Housing and the Presser Flange

Since the Cross-Roller Ring is a compact, thin device, special consideration must be given to the rigidity of the housing and the presser flange.

With types having a separable outer ring, insufficiency in the strength of the housing, the flange or the presser bolt will result in the inability to evenly hold the inner or outer ring, or will cause deformation of the bearing when a moment load is applied. Consequently, the contact area of the rollers will become uneven, causing the bearing's performance to significantly deteriorate.

#### [Housing]

When determining the thickness of the housing, at least 60% of the sectional height of the bearing must be secured as a guide.

$$T = \frac{D-d}{2} \times 0.6 \text{ or greater}$$

T : Housing thickness

D : Outer diameter of the outer ring

d : Inner diameter of the inner ring

### ● Tapped Through Holes

If tapped through holes for removing the inner or outer ring (Fig. 1) are provided, the ring can be removed without causing damage to the bearing. When removing the outer ring, do not press the inner ring, or vice versa. For the dimensions of the presser on the side(s), see the shoulder dimensions indicated in the dimensional table.

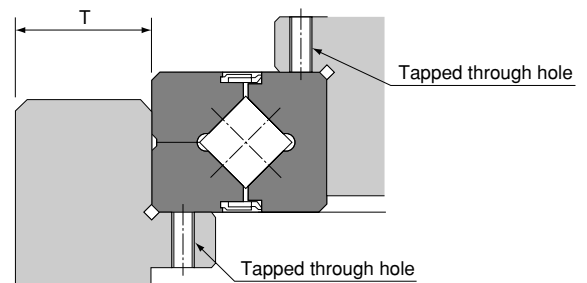
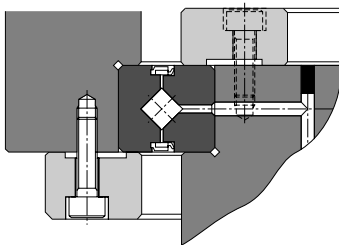

Fig. 1

#### [Examples of installation]

Fig. 2 shows examples of installing the Cross-Roller Ring.



a. Outer ring rotating in the swiveling unit:  
An example of mounting the heavy body part after securing the inner and outer rings of the Cross-Roller Ring

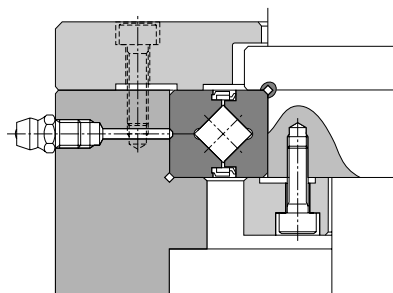

b. Inner ring rotation with the swiveling unit (with seals attached)

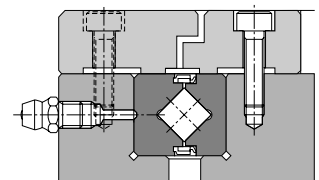

c. The inner and outer rings are secured in the same direction in the swiveling unit (with seals attached)

Fig. 2 Examples of Installation

## [Presser Flange and Presser Bolt]

When determining the thickness of the presser flange (F) or the clearance of the flange section (S), refer to the dimensions indicated below as a guide. As for the number of presser bolts, the greater the number of bolts, the more stable the system becomes. As a guide, however, it is advised to select the appropriate number of bolts indicated in Table 23 and arrange them equidistantly.

$$F = B \times 0.5 \text{ to } B \times 1.2$$

$$H = B_{-0.1}$$

$$S = 0.5 \text{ mm}$$

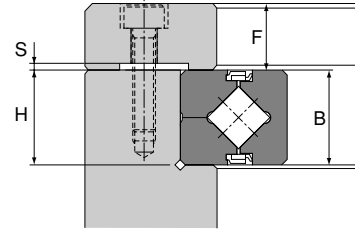

Even if the shaft and the housing are composed of a light alloy, it is recommended to select a steel-based material for the presser flange.

When tightening the presser bolts, firmly secure them using a torque wrench or the like so that they will not loosen.

Table 24 shows tightening torques for the housing and presser flanges composed of typical steel materials with medium hardness.

Table 23 Number of Presser Bolts and Bolt Sizes Unit: mm

Outer diameter of the outer ring (D)		No. of bolts	Bolt size (reference)
Above	Or less		
—	100	8 or more	M3 to M5
100	200	12 or more	M4 to M8
200	500	16 or more	M5 to M12
500	—	24 or more	M12 or greater

Table 24 Tightening Torque of the Bolt Unit: N·m

Nominal size of screw	Tightening torque	Nominal size of screw	Tightening torque
M3	2	M10	70
M4	4	M12	120
M5	9	M16	200
M6	14	M20	390
M8	30	M22	530

## Installation Procedure

When installing the Cross-Roller Ring, follow the procedure below.

### [Checking the Parts before Installing Them]

Thoroughly clean the housing and other parts to be installed, and check to determine if deburring is required.

### [Installing the Cross-Roller Ring into the Housing or onto the Shaft]

Since the Cross-Roller Ring is a thin-wall bearing type and therefore tends to misalign when it is installed, gradually drive the product into the housing or onto the shaft by gently hitting it with a plastic hammer while keeping the product horizontal. Taking care, continue to hammer until it fully contacts the reference surface.

Note: When installing the inner ring, hammer it, and when installing the outer ring, hammer it.

### [Attaching the Presser Flange]

- (1) When attaching the presser flange, attach it to the integrated rotation ring (i.e., inner ring of models RB and RA, or outer ring of model RE) first.
- (2) Place the presser flange onto the Cross-Roller Ring. Rock the flange several times to match the bolt holes.
- (3) Insert the presser bolts into the holes. Manually turn the bolts and make sure they do not display skewing caused by misalignment of the holes.
- (4) Tighten the presser bolts in three to four steps from light to full tightening by repeatedly securing the bolts in diagonal order. When tightening the separable inner or outer ring, slightly turning the integral outer or inner ring will correct the dislocation between the ring and the body.

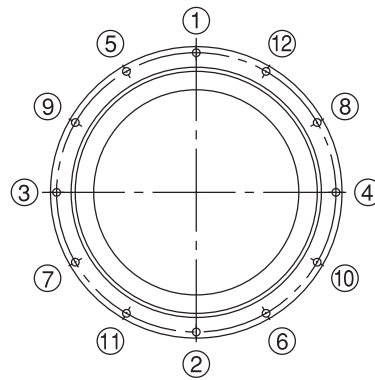
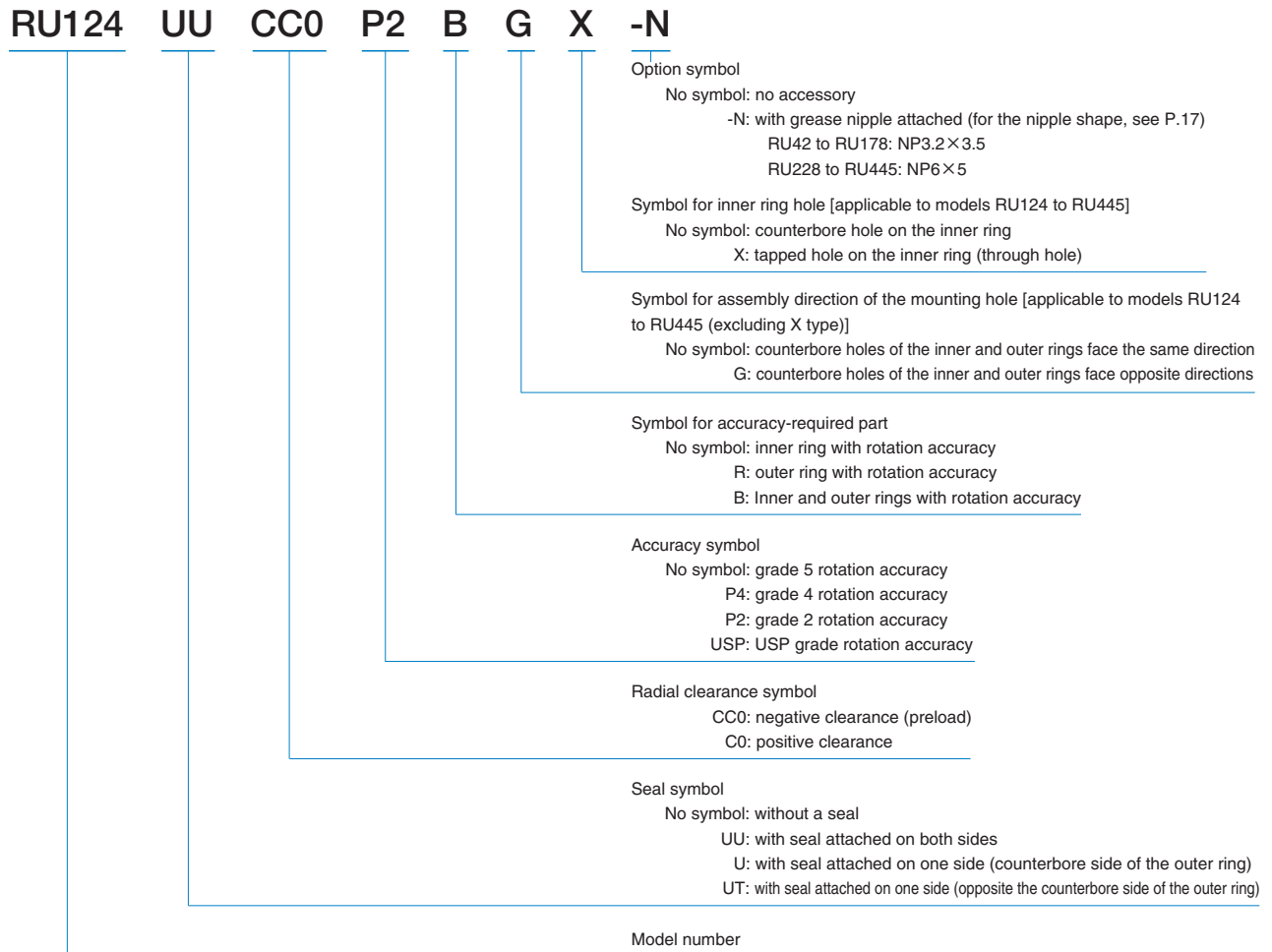

Fig. 1 Tightening Order



### Example of Model Number Coding

#### [Example of Model Number Coding for Model RU]



#### [Example of Model Number Coding for Models RB, RE, RA and RA-C]

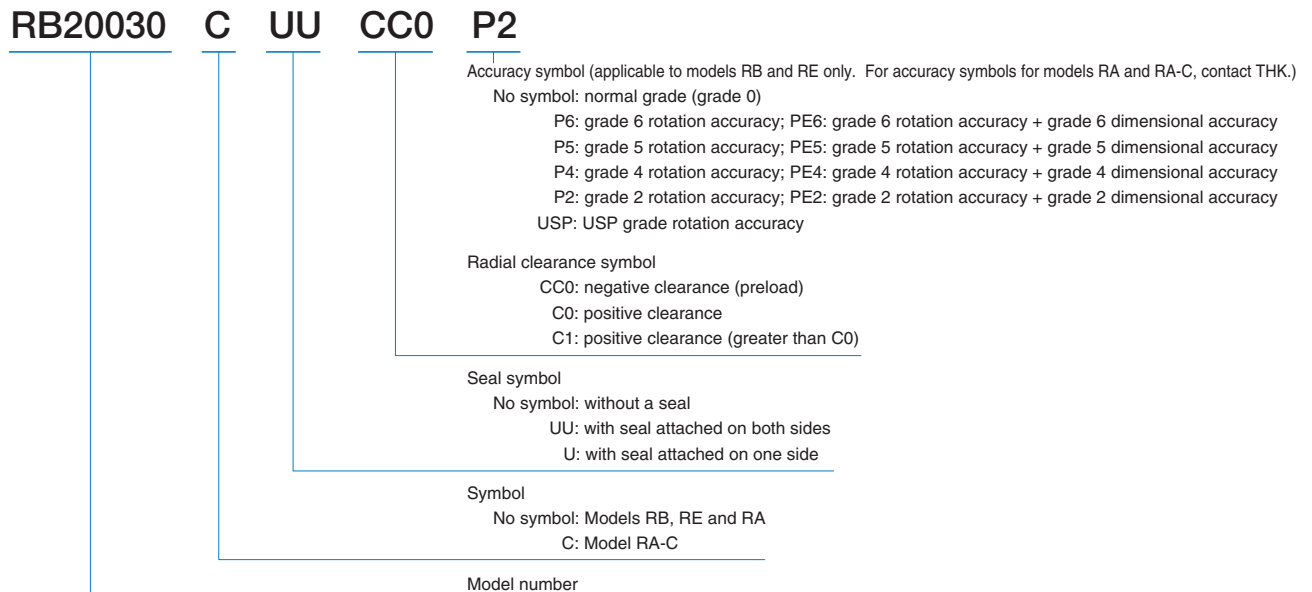

# RU TYPE

## Model RU (Integrated Inner and Outer Rings)

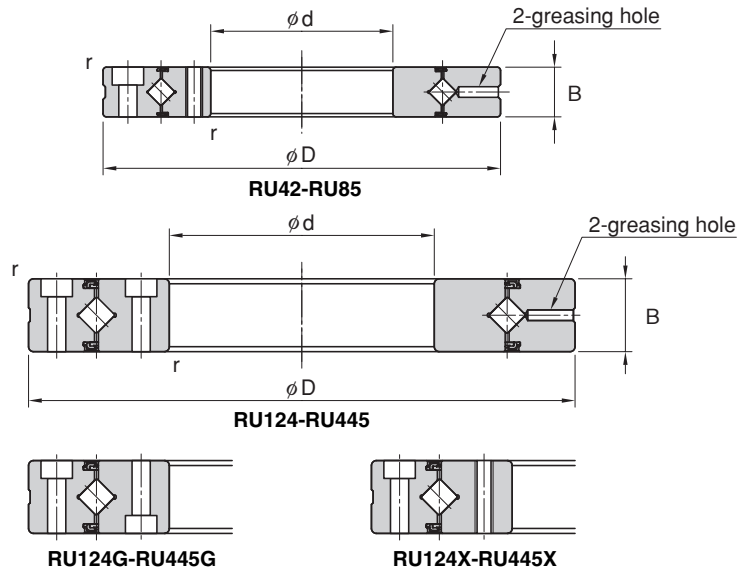

Shaft diameter	Model No.	Major dimensions						Shoulder dimensions		Basic load rating (radial)		Mass kg
		Inner diameter	Outer diameter	Roller pitch circle diameter	Width	Greasing hole			C	C <sub>0</sub>		
		d	D	d <sub>p</sub>	B	d <sub>1</sub>	r <sub>min</sub>	d <sub>s</sub>	D <sub>h</sub>	kN	kN	
20	<b>RU 42</b>	20	70	41.5	12	3.1	0.6	37	47	7.35	8.35	0.29
35	<b>RU 66</b>	35	95	66	15	3.1	0.6	59	74	17.5	22.3	0.62
55	<b>RU 85</b>	55	120	85	15	3.1	0.6	79	93	20.3	29.5	1
80	<b>RU 124(G)</b>	80	165	124	22	3.1	1	114	134	33.1	50.9	2.6
	<b>RU 124X</b>											
90	<b>RU 148(G)</b>	90	210	147.5	25	3.1	1.5	133	162	49.1	76.8	4.9
	<b>RU 148X</b>											
115	<b>RU 178(G)</b>	115	240	178	28	3.1	1.5	161	195	80.3	135	6.8
	<b>RU 178X</b>											
160	<b>RU 228(G)</b>	160	295	227.5	35	6	2	208	246	104	173	11.4
	<b>RU 228X</b>											
210	<b>RU 297(G)</b>	210	380	297.3	40	6	2.5	272	320	156	281	21.3
	<b>RU 297X</b>											
350	<b>RU 445(G)</b>	350	540	445.4	45	6	2.5	417	473	222	473	35.4
	<b>RU 445X</b>											

**Note** For the model number coding, see P.16.

### Option

For model RU, a grease nipple is available as an option (see the figure below).

If the grease nipple is required, add “-N” at the end of the model number when placing an order.

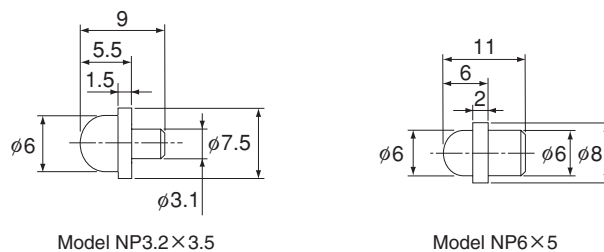

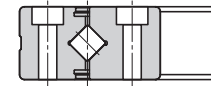
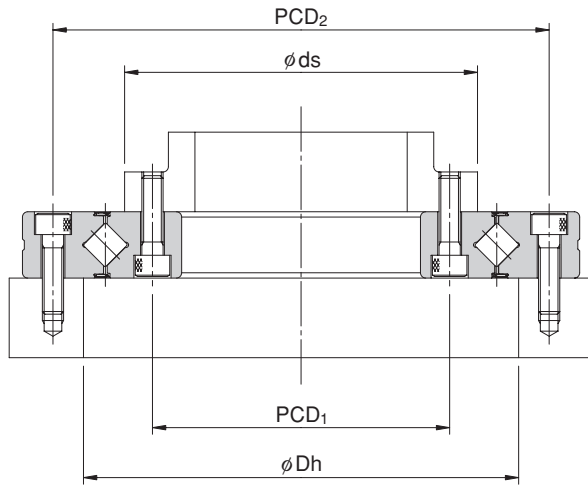

**Model RU**

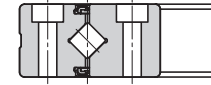

**Model RU...UU**

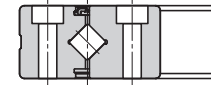

**Model RU...U**

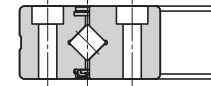

**Model RU...UT**

Unit: mm

Relation between the mounting holes					Model No.
Inner ring			Outer ring		
PCD <sub>1</sub>	Mounting hole	PCD <sub>2</sub>	Mounting hole		
28	6-M3 through	57	6- $\phi$ 3.4 through $\phi$ 6.5 counterbore depth 3.3	<b>RU 42</b>	
45	8-M4 through	83	8- $\phi$ 4.5 through $\phi$ 8 counterbore depth 4.4	<b>RU 66</b>	
65	8-M5 through	105	8- $\phi$ 5.5 through $\phi$ 9.5 counterbore depth 5.4	<b>RU 85</b>	
97	10- $\phi$ 5.5 through $\phi$ 9.5 counterbore depth 5.4	148	10- $\phi$ 5.5 through $\phi$ 9.5 counterbore depth 5.4	<b>RU 124(G)</b>	
	10-M5 through			<b>RU 124X</b>	
112	12- $\phi$ 9 through $\phi$ 14 counterbore depth 8.6	187	12- $\phi$ 9 through $\phi$ 14 counterbore depth 8.6	<b>RU 148(G)</b>	
	12-M8 through			<b>RU 148X</b>	
139	12- $\phi$ 9 through $\phi$ 14 counterbore depth 8.6	217	12- $\phi$ 9 through $\phi$ 14 counterbore depth 8.6	<b>RU 178(G)</b>	
	12-M8 through			<b>RU 178X</b>	
184	12- $\phi$ 11 through $\phi$ 17.5 counterbore depth 10.8	270	12- $\phi$ 11 through $\phi$ 17.5 counterbore depth 10.8	<b>RU 228(G)</b>	
	12-M10 through			<b>RU 228X</b>	
240	16- $\phi$ 14 through $\phi$ 20 counterbore depth 13	350	16- $\phi$ 14 through $\phi$ 20 counterbore depth 13	<b>RU 297(G)</b>	
	16-M12 through			<b>RU 297X</b>	
385	24- $\phi$ 14 through $\phi$ 20 counterbore depth 13	505	24- $\phi$ 14 through $\phi$ 20 counterbore depth 13	<b>RU 445(G)</b>	
	24-M12 through			<b>RU 445X</b>	

# RB TYPE

## Model RB (Separable Outer Ring Type)

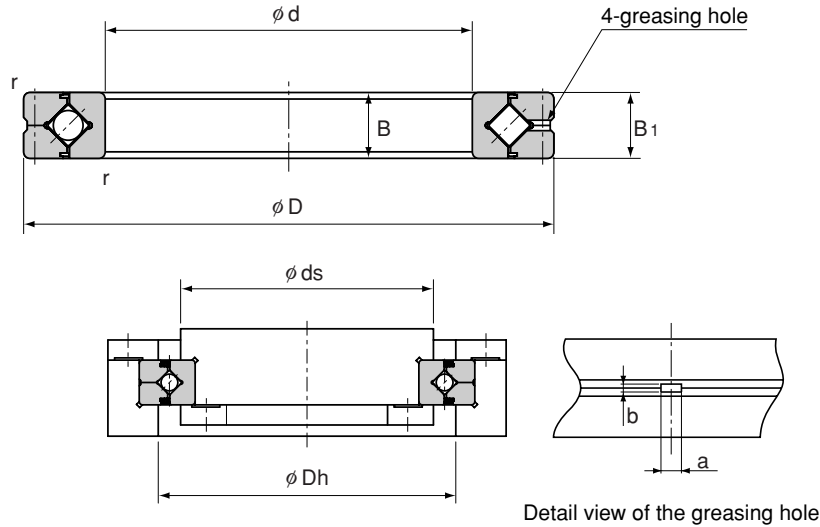

Unit: mm

Shaft diameter	Model No.	Major dimensions							Shoulder dimensions		Basic load rating (radial)		Mass kg
		Inner diameter d	Outer diameter D	Roller pitch circle diameter dp	Width B B <sub>1</sub>	Greasing hole		r <sub>min</sub>	ds	Dh	C kN	C <sub>0</sub> kN	
						a	b						
20	<b>RB 2008</b>	20	36	27	8	2	0.8	0.5	23.5	30.5	3.23	3.1	0.04
25	<b>RB 2508</b>	25	41	32	8	2	0.8	0.5	28.5	35.5	3.63	3.83	0.05
30	<b>RB 3010</b>	30	55	41.5	10	2.5	1	0.6	37	47	7.35	8.36	0.12
35	<b>RB 3510</b>	35	60	46.5	10	2.5	1	0.6	41	51.5	7.64	9.12	0.13
40	<b>RB 4010</b>	40	65	51.5	10	2.5	1	0.6	47.5	57.5	8.33	10.6	0.16
45	<b>RB 4510</b>	45	70	56.5	10	2.5	1	0.6	51	61.5	8.62	11.3	0.17
50	<b>RB 5013</b>	50	80	64	13	2.5	1.6	0.6	57.4	72	16.7	20.9	0.27
60	<b>RB 6013</b>	60	90	74	13	2.5	1.6	0.6	68	82	18	24.3	0.3
70	<b>RB 7013</b>	70	100	84	13	2.5	1.6	0.6	78	92	19.4	27.7	0.35
80	<b>RB 8016</b>	80	120	98	16	3	1.6	0.6	91	111	30.1	42.1	0.7
90	<b>RB 9016</b>	90	130	108	16	3	1.6	1	98	118	31.4	45.3	0.75
100	<b>RB 10016</b>	100	140	119.3	16	3.5	1.6	1	109	129	31.7	48.6	0.83
	<b>RB 10020</b>		150	123	20	3.5	1.6	1	113	133	33.1	50.9	1.45
110	<b>RB 11012</b>	110	135	121.8	12	2.5	1	0.6	117	127	12.5	24.1	0.4
	<b>RB 11015</b>		145	126.5	15	3.5	1.6	0.6	122	136	23.7	41.5	0.75
	<b>RB 11020</b>		160	133	20	3.5	1.6	1	120	143	34	54	1.56
120	<b>RB 12016</b>	120	150	134.2	16	3.5	1.6	0.6	127	141	24.2	43.2	0.72
	<b>RB 12025</b>		180	148.7	25	3.5	2	1.5	133	164	66.9	100	2.62
130	<b>RB 13015</b>	130	160	144.5	15	3.5	1.6	0.6	137	152	25	46.7	0.72
	<b>RB 13025</b>		190	158	25	3.5	2	1.5	143	174	69.5	107	2.82
140	<b>RB 14016</b>	140	175	154.8	16	2.5	1.6	1	147	162	25.9	50.1	1
	<b>RB 14025</b>		200	168	25	3.5	2	1.5	154	185	74.8	121	2.96
150	<b>RB 15013</b>	150	180	164	13	2.5	1.6	0.6	157	172	27	53.5	0.68
	<b>RB 15025</b>		210	178	25	3.5	2	1.5	164	194	76.8	128	3.16
	<b>RB 15030</b>		230	188	30	4.5	3	1.5	173	211	100	156	5.3
160	<b>RB 16025</b>	160	220	188.6	25	3.5	2	1.5	173	204	81.7	135	3.14

**Note** Model number of a part with seals attached is RB···UU.  
 If a certain level of accuracy is required, use this model for inner ring rotation.  
 For the model number coding, see P.16.

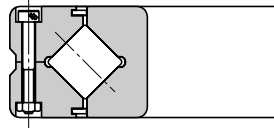

Model RB

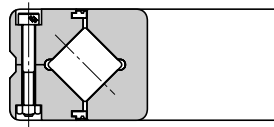

Model RB...UU

Unit: mm

Shaft diameter	Model No.	Major dimensions							Shoulder dimensions		Basic load rating (radial)		Mass
		Inner diameter	Outer diameter	Roller pitch circle diameter	Width	Greasing hole		$r_{min}$	ds	Dh	C	C <sub>0</sub>	
						a	b						
170	<b>RB 17020</b>	170	220	191	20	3.5	1.6	1.5	184	198	29	62.1	2.21
180	<b>RB 18025</b>	180	240	210	25	3.5	2	1.5	195	225	84	143	3.44
190	<b>RB 19025</b>	190	240	211.9	25	3.5	1.6	1	202	222	41.7	82.9	2.99
200	<b>RB 20025</b>	200	260	230	25	3.5	2	2	215	245	84.2	157	4
	<b>RB 20030</b>		280	240	30	4.5	3	2	221	258	114	200	6.7
	<b>RB 20035</b>		295	247.7	35	5	3	2	225	270	151	252	9.6
220	<b>RB 22025</b>	220	280	250.1	25	3.5	2	2	235	265	92.3	171	4.1
240	<b>RB 24025</b>	240	300	269	25	3.5	2	2.5	256	281	68.3	145	4.5
250	<b>RB 25025</b>	250	310	277.5	25	3.5	2	2.5	265	290	69.3	150	5
	<b>RB 25030</b>		330	287.5	30	4.5	3	2.5	269	306	126	244	8.1
	<b>RB 25040</b>		355	300.7	40	6	3.5	2.5	275	326	195	348	14.8
300	<b>RB 30025</b>	300	360	328	25	3.5	2	2.5	315	340	76.3	178	5.9
	<b>RB 30035</b>		395	345	35	5	3	2.5	322	368	183	367	13.4
	<b>RB 30040</b>		405	351.6	40	6	3.5	2.5	326	377	212	409	17.2
350	<b>RB 35020</b>	350	400	373.4	20	3.5	1.6	2.5	363	383	54.1	143	3.9
400	<b>RB 40035</b>	400	480	440.3	35	5	3	2.5	422	459	156	370	14.5
	<b>RB 40040</b>		510	453.4	40	6	3.5	2.5	428	479	241	531	23.5
450	<b>RB 45025</b>	450	500	474	25	3.5	1.6	1	464	484	61.7	182	6.6
500	<b>RB 50025</b>	500	550	524.2	25	3.5	1.6	1	514	534	65.5	201	7.3
	<b>RB 50040</b>		600	548.8	40	6	3	2.5	526	572	239	607	26
	<b>RB 50050</b>		625	561.6	50	6	3.5	2.5	536	587	267	653	41.7
600	<b>RB 60040</b>	600	700	650	40	6	3	3	627	673	264	721	29
700	<b>RB 70045</b>	700	815	753.5	45	6	3	3	731	777	281	836	46
800	<b>RB 80070</b>	800	950	868.1	70	6	4	4	836	900	468	1330	105
900	<b>RB 90070</b>	900	1050	969	70	6	4	4	937	1001	494	1490	120
1000	<b>RB 1000110</b>	1000	1250	1114	110	6	6	5	1057	1171	1220	3220	360
1250	<b>RB 1250110</b>	1250	1500	1365.8	110	6	6	5	1308	1423	1350	3970	440

**Note** Model number of a part with seals attached is RB...UU.  
 If a certain level of accuracy is required, use this model for inner ring rotation.  
 For the model number coding, see P.16.

# RE TYPE

## Model RE (Separable Inner Ring Type)

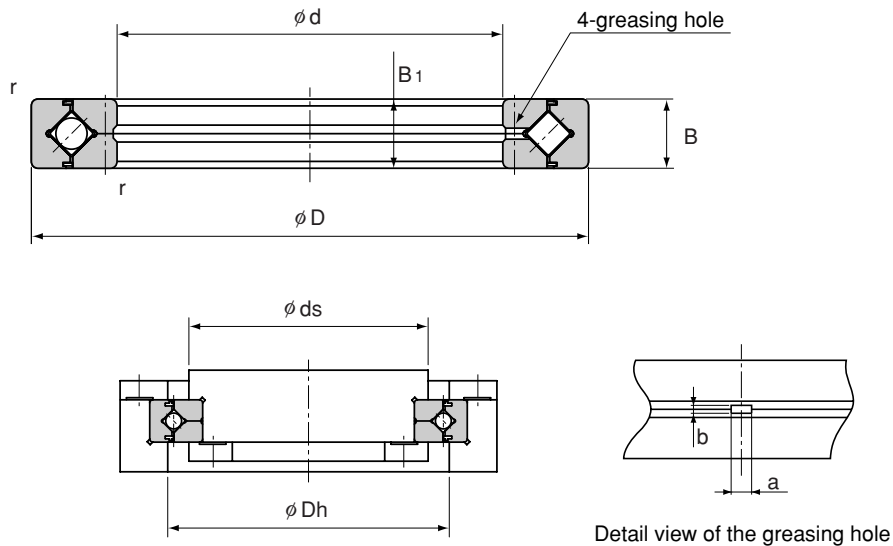

Unit: mm

Shaft diameter	Model No.	Major dimensions							Shoulder dimensions		Basic load rating (radial)		Mass kg
		Inner diameter d	Outer diameter D	Roller pitch circle diameter dp	Width B B <sub>1</sub>	Greasing hole		r <sub>min</sub>	ds	Dh	C kN	C <sub>0</sub> kN	
						a	b						
20	RE 2008	20	36	29	8	2	0.8	0.5	23.5	30.5	3.23	3.1	0.04
25	RE 2508	25	41	34	8	2	0.8	0.5	28.5	35.5	3.63	3.83	0.05
30	RE 3010	30	55	43.5	10	2.5	1	0.6	37	47	7.35	8.36	0.12
35	RE 3510	35	60	48.5	10	2.5	1	0.6	41	51.5	7.64	9.12	0.13
40	RE 4010	40	65	53.5	10	2.5	1	0.6	47.5	58	8.33	10.6	0.16
45	RE 4510	45	70	58.5	10	2.5	1	0.6	51	61.5	8.62	11.3	0.17
50	RE 5013	50	80	66	13	2.5	1.6	0.6	57.5	72	16.7	20.9	0.27
60	RE 6013	60	90	76	13	2.5	1.6	0.6	68	82	18	24.3	0.3
70	RE 7013	70	100	86	13	2.5	1.6	0.6	78	92	19.4	27.7	0.35
80	RE 8016	80	120	101.4	16	3	1.6	0.6	91	111	30.1	42.1	0.7
90	RE 9016	90	130	112	16	3	1.6	1	98	118	31.4	45.3	0.75
100	RE 10016	100	140	121.1	16	3	1.6	1	109	129	31.7	48.6	0.83
	RE 10020		150	127	20	3.5	1.6	1	113	133	33.1	50.9	1.45
110	RE 11012	110	135	123.3	12	2.5	1	0.6	117	127	12.5	24.1	0.4
	RE 11015		145	129	15	3	1.6	0.6	122	136	23.7	41.5	0.75
	RE 11020		160	137	20	3.5	1.6	1	120	140	34	54	1.56
120	RE 12016	120	150	136	16	3	1.6	0.6	127	141	24.2	43.2	0.72
	RE 12025		180	152	25	3.5	2	1.5	133	164	66.9	100	2.62
130	RE 13015	130	160	146	15	3	1.6	0.6	137	152	25	46.7	0.72
	RE 13025		190	162	25	3.5	2	1.5	143	174	69.5	107	2.82

**Note** Model number of a part with seals attached is RE...UU.  
 If a certain level of accuracy is required, use this model for outer ring rotation.  
 For the model number coding, see P.16.

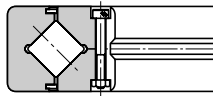

Model RE

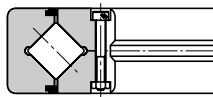

Model RE...UU

Unit: mm

Shaft diameter	Model No.	Major dimensions							Shoulder dimensions		Basic load rating (radial)		Mass
		Inner diameter d	Outer diameter D	Roller pitch circle diameter dp	Width B B <sub>1</sub>	Greasing hole		r <sub>min</sub>	ds	Dh	C	C <sub>0</sub>	
						a	b						
140	RE 14016	140	175	160	16	3	1.6	1	147	162	25.9	50.1	1
	RE 14025		200	172	25	3.5	2	1.5	154	185	74.8	121	2.96
150	RE 15013	150	180	166	13	2.5	1.6	0.6	158	172	27	53.5	0.68
	RE 15025		210	182	25	3.5	2	1.5	164	194	76.8	128	3.16
	RE 15030		230	192	30	4.5	3	1.5	173	210	100	156	5.3
160	RE 16025	160	220	192	25	3.5	2	1.5	173	204	81.7	135	3.14
170	RE 17020	170	220	196.1	20	3.5	1.6	1.5	184	198	29	62.1	2.21
180	RE 18025	180	240	210	25	3.5	2	1.5	195	225	84	143	3.44
190	RE 19025	190	240	219	25	3.5	1.6	1	202	222	41.7	82.9	2.99
200	RE 20025	200	260	230	25	3.5	2	2	215	245	84.2	157	4
	RE 20030		280	240	30	4.5	3	2	221	258	114	200	6.7
	RE 20035		295	247.7	35	5	3	2	225	270	151	252	9.6
220	RE 22025	220	280	250.1	25	3.5	2	2	235	265	92.3	171	4.1
240	RE 24025	240	300	272.5	25	3.5	2	2.5	256	281	68.3	145	4.5
250	RE 25025	250	310	280.9	25	3.5	2	2.5	268	293	69.3	150	5
	RE 25030		330	287.5	30	4.5	3	2.5	269	306	126	244	8.1
	RE 25040		355	300.7	40	6	3.5	2.5	275	326	195	348	14.8
300	RE 30025	300	360	332	25	3.5	2	2.5	319	344	75.5	178	5.9
	RE 30035		395	345	35	5	3	2.5	322	368	183	367	13.4
	RE 30040		405	351.6	40	6	3.5	2.5	326	377	212	409	17.2
350	RE 35020	350	400	376.6	20	3.5	1.6	2.5	363	383	54.1	143	3.9

**Note** Model number of a part with seals attached is RE...UU.  
 If a certain level of accuracy is required, use this model for outer ring rotation.  
 For the model number coding, see P.16.

# RE TYPE

## Model RE (Separable Inner Ring Type)

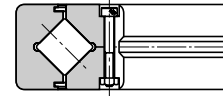
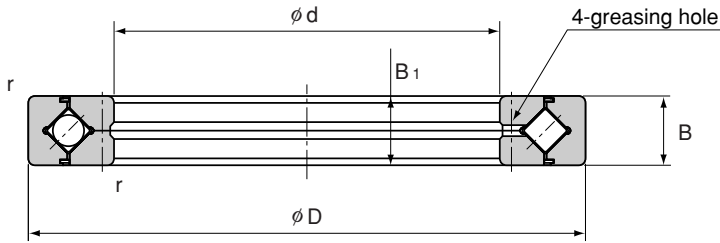

Model RE

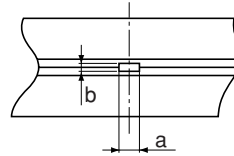
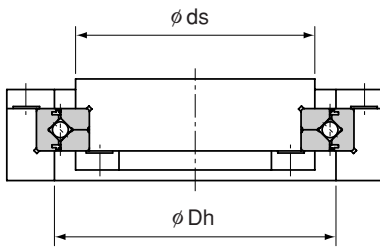

Detail view of the greasing hole

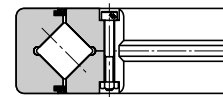

Model RE...UU

Unit: mm

Shaft diameter	Model No.	Major dimensions							Shoulder dimensions		Basic load rating (radial)		Mass
		Inner diameter d	Outer diameter D	Roller pitch circle diameter dp	Width B B <sub>1</sub>	Greasing hole		r <sub>min</sub>	ds	Dh	C kN	C <sub>0</sub> kN	
						a	b						
400	RE 40035	400	480	440.3	35	5	3	2.5	422	459	156	370	14.5
	RE 40040		510	453.4	40	6	3.5	2.5	428	479	241	531	23.5
450	RE 45025	450	500	476.6	25	3.5	1.6	1	464	484	61.7	182	6.6
	RE 50025		550	526.6	25	3.5	1.6	1	514	534	65.5	201	7.3
500	RE 50040	500	600	548.8	40	6	3	2.5	526	572	239	607	26
	RE 50050		625	561.6	50	6	3.5	2.5	536	587	267	653	41.7
600	RE 60040	600	700	650	40	6	3	3	627	673	264	721	29

**Note**

Model number of a part with seals attached is RE...UU.  
 If a certain level of accuracy is required, use this model for outer ring rotation.  
 For the model number coding, see P.16.



# RB TYPE / RE TYPE - USP CLASS

## USP-Grade Series of Models RB/RE

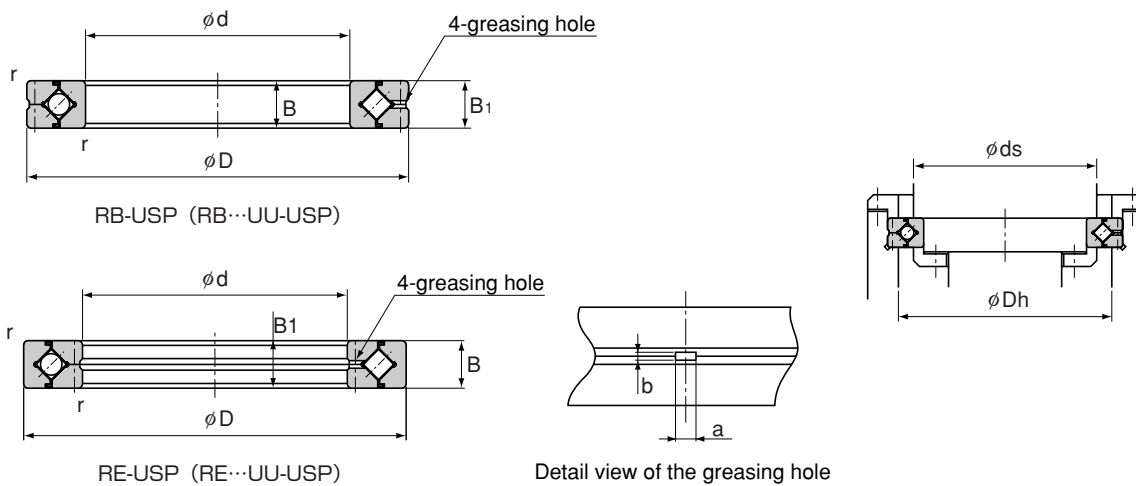

Unit: mm

Model No.	Major dimensions							Shoulder dimensions		Basic load rating (radial)		Mass	
	Inner diameter d	Outer diameter D	Roller pitch circle diameter dp		Width B B <sub>1</sub>	Greasing hole		r <sub>min</sub>	ds	Dh	C kN		C <sub>0</sub> kN
			RB	RE		a	b					kg	
RB 10020USP RE 10020USP	100	150	123	127	20	3.5	1.6	1	113	133	33.1	50.9	1.45
RB 12025USP RE 12025USP	120	180	148.7	152	25	3.5	2	1.5	133	164	66.9	100	2.62
RB 15025USP RE 15025USP	150	210	178	182	25				164	194	76.8	128	3.16
RB 20030USP RE 20030USP	200	280	240	240	30	4.5	3	2	221	258	114	200	6.7
RB 25030USP RE 25030USP	250	330	287.5	287.5	30				269	306	126	244	8.1
RB 30035USP RE 30035USP	300	395	345	345	35	5	3	2.5	322	368	183	367	13.4
RB 40040USP RE 40040USP	400	510	453.4	453.4	40	6	3.5		428	479	241	531	23.5
RB 50040USP RE 50040USP	500	600	548.8	548.8	40	6	3		526	572	239	607	26
RB 60040USP RE 60040USP	600	700	650	650	40			3	627	673	264	721	29



Model number of a part with seals attached is RB...UU-USP or RE...UU-USP.

If a certain level of rotation accuracy is required for the inner ring, select model RB. If a certain level of rotation accuracy is required for the outer ring, select model RE.

For the model number coding, see P.16.

# RA TYPE

## Model RA (Separable Outer Ring Type)

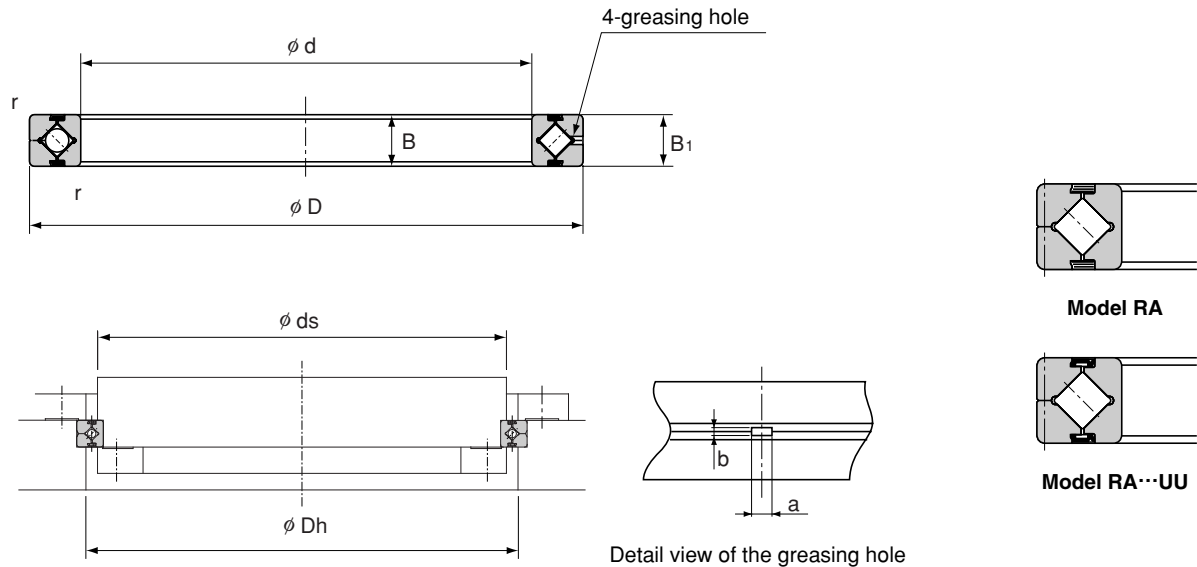

Unit: mm

Shaft diameter	Model No.	Major dimensions							Shoulder dimensions		Basic load rating (radial)		Mass
		Inner diameter d	Outer diameter D	Roller pitch circle diameter dp	Width B B <sub>1</sub>	Greasing hole		r <sub>min</sub>	ds	Dh	C	C <sub>0</sub>	
						a	b						
50	RA 5008	50	66	57	8	2	0.8	0.5	53.5	60.5	5.1	7.19	0.08
60	RA 6008	60	76	67	8	2	0.8	0.5	63.5	70.5	5.68	8.68	0.09
70	RA 7008	70	86	77	8	2	0.8	0.5	73.5	80.5	5.98	9.8	0.1
80	RA 8008	80	96	87	8	2	0.8	0.5	83.5	90.5	6.37	11.3	0.11
90	RA 9008	90	106	97	8	2	0.8	0.5	93.5	100.5	6.76	12.4	0.12
100	RA 10008	100	116	107	8	2	0.8	0.5	103.5	110.5	7.15	13.9	0.14
110	RA 11008	110	126	117	8	2	0.8	0.5	113.5	120.5	7.45	15	0.15
120	RA 12008	120	136	127	8	2	0.8	0.5	123.5	130.5	7.84	16.5	0.17
130	RA 13008	130	146	137	8	2	0.8	0.5	133.5	140.5	7.94	17.6	0.18
140	RA 14008	140	156	147	8	2	0.8	0.5	143.5	150.5	8.33	19.1	0.19
150	RA 15008	150	166	157	8	2	0.8	0.5	153.5	160.5	8.82	20.6	0.2
160	RA 16013	160	186	172	13	2.5	1.6	0.8	165	179	23.3	44.9	0.59
170	RA 17013	170	196	182	13	2.5	1.6	0.8	175	189	23.5	46.5	0.64
180	RA 18013	180	206	192	13	2.5	1.6	0.8	185	199	24.5	49.8	0.68
190	RA 19013	190	216	202	13	2.5	1.6	0.8	195	209	24.9	51.5	0.69
200	RA 20013	200	226	212	13	2.5	1.6	0.8	205	219	25.8	54.7	0.71

**Note**

Model number of a part with seals attached is RA...UU.  
 If a certain level of accuracy is required, use this model for inner ring rotation.  
 For the model number coding, see P.16.

# RA-C TYPE

## Model RA-C (Single-Split Type)

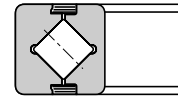
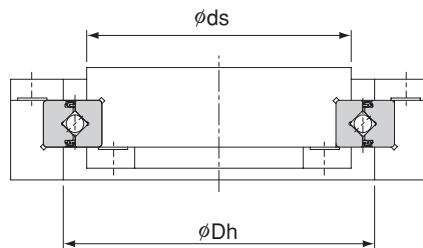
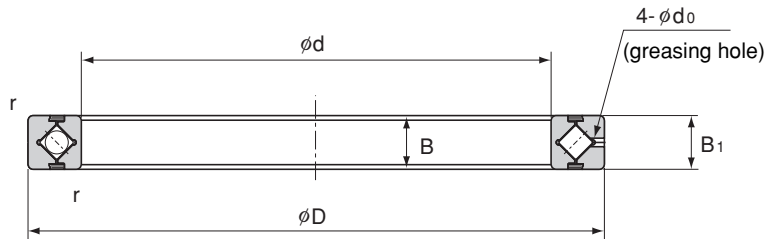

Model RA...C

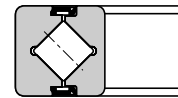

Model RA...CUU

Unit: mm

Shaft diameter	Model No.	Major dimensions						Shoulder dimensions		Basic load rating (radial)		Mass kg
		Inner diameter d	Outer diameter D	Roller pitch circle diameter $d_p$	Width B $B_1$	Greasing hole $d_0$	$r_{min}$	$d_s$	$D_h$	C kN	$C_0$ kN	
50	RA 5008C	50	66	57	8	1.5	0.5	53.5	60.5	5.1	7.19	0.08
60	RA 6008C	60	76	67	8	1.5	0.5	63.5	70.5	5.68	8.68	0.09
70	RA 7008C	70	86	77	8	1.5	0.5	73.5	80.5	5.98	9.8	0.1
80	RA 8008C	80	96	87	8	1.5	0.5	83.5	90.5	6.37	11.3	0.11
90	RA 9008C	90	106	97	8	1.5	0.5	93.5	100.5	6.76	12.4	0.12
100	RA 10008C	100	116	107	8	1.5	0.5	103.5	110.5	7.15	13.9	0.14
110	RA 11008C	110	126	117	8	1.5	0.5	113.5	120.5	7.45	15	0.15
120	RA 12008C	120	136	127	8	1.5	0.5	123.5	130.5	7.84	16.5	0.17
130	RA 13008C	130	146	137	8	1.5	0.5	133.5	140.5	7.94	17.6	0.18
140	RA 14008C	140	156	147	8	1.5	0.5	143.5	150.5	8.33	19.1	0.19
150	RA 15008C	150	166	157	8	1.5	0.5	153.5	160.5	8.82	20.6	0.2
160	RA 16013C	160	186	172	13	2	0.8	165	179	23.3	44.9	0.59
170	RA 17013C	170	196	182	13	2	0.8	175	189	23.5	46.5	0.64
180	RA 18013C	180	206	192	13	2	0.8	185	199	24.5	49.8	0.68
190	RA 19013C	190	216	202	13	2	0.8	195	209	24.9	51.5	0.69
200	RA 20013C	200	226	212	13	2	0.8	205	219	25.8	54.7	0.71

**Note**

Model number of a part with seals attached is RA...CUU.  
 If a certain level of accuracy is required, use this model for inner ring rotation.  
 For the model number coding, see P.16.

## Precautions on use

### ● Handling

- The separable inner or outer ring is fastened in place using special rivets, bolts or nuts when delivered. When installing it to the system, do not disassemble it. Also, erroneously installing the spacer retainer will significantly affect the rotational performance of the system. Do not disassemble the bearing.
- The matching mark of the inner or outer ring may be slightly misaligned when delivered. In that case, loosen the bolts that secure the inner or outer ring, and correct the alignment using a plastic hammer or the like, before installing it to the housing (let the securing rivets follow the housing).
- When installing or removing the Cross-Roller Ring, do not apply force to the securing rivets or the bolts.
- When mounting the presser flange, take into account the dimensional tolerances of the parts so that the flange firmly holds the inner and outer ring from the side.
- Dropping or hitting the Cross-Roller Ring may damage it. Giving an impact to it could also cause damage to its function even if the product looks intact.

### ● Lubrication

- Since each Cross-Roller Ring unit contains high-quality lithium soap group grease No. 2, you can start using the product without replenishing grease. However, the product requires regular lubrication since it has a smaller internal space than ordinary roller bearings and because the rollers need frequent lubrication due to their rolling contact structure. To replenish grease, it is necessary to secure greasing holes that lead to the oil grooves formed on the inner and outer rings. As for the lubrication interval, normally replenish grease of the same group so that it is distributed throughout the interior of the bearing at least every six to twelve months. When the bearing is filled up with grease, the initial rotation torque temporarily increases. However, surplus grease will run off of the seals and the torque will return to the normal level in a short period. The thin type does not have an oil groove. Secure an oil groove inside the housing for lubrication.
- Do not mix lubricants of different physical properties.
- In locations exposed to constant vibrations or in special environments such as clean rooms, vacuum and low/high temperature, normal lubricants may not be used. Contact THK for details.
- When planning to use a special lubricant, contact THK before using it.

### ● Precautions on Use

- Entrance of foreign matter may cause functional loss. Prevent foreign matter, such as dust or cutting chips, from entering the system.
- When desiring to use the system at temperature of 80°C or higher, contact THK in advance.
- If planning to use the Cross-Roller Ring in an environment where a coolant penetrates into the product, contact THK.
- If foreign matter adheres to the product, replenish the lubricant after cleaning the product with clean white kerosene.
- When using the product in locations exposed to constant vibrations or in special environments such as clean rooms, vacuum and low/high temperature, contact THK in advance.

### ● “LM GUIDE” and “” are registered trademarks of THK CO., LTD.

- The photo may differ slightly in appearance from the actual product.
  - The appearance and specifications of the product are subject to change without notice. Contact THK before placing an order.
  - Although great care has been taken in the production of this catalog, THK will not take any responsibility for damage resulting from typographical errors or omissions.
  - For the export of our products or technologies and for the sale for exports, THK in principle complies with the foreign exchange law and the Foreign Exchange and Foreign Trade Control Law as well as other relevant laws.
- For export of THK products as single items, contact THK in advance.

All rights reserved

# THK CO., LTD.

HEAD OFFICE 3-11-6, NISHI-GOTANDA, SHINAGAWA-KU, TOKYO 141-8503 JAPAN  
INTERNATIONAL SALES DEPARTMENT PHONE:+81-3-5434-0351 FAX:+81-3-5434-0353  
Global site : <http://www.thk.com/>

#### NORTH AMERICA

THK America, Inc.  
● HEADQUARTERS  
Phone:+1-847-310-1111 Fax:+1-847-310-1271  
● CHICAGO OFFICE  
Phone:+1-847-310-1111 Fax:+1-847-310-1182  
● NORTH EAST OFFICE  
Phone:+1-845-369-4035 Fax:+1-845-369-4909  
● ATLANTA OFFICE  
Phone:+1-770-840-7990 Fax:+1-770-840-7897  
● LOS ANGELES OFFICE  
Phone:+1-949-955-3145 Fax:+1-949-955-3149  
● SAN FRANCISCO OFFICE  
Phone:+1-925-455-8948 Fax:+1-925-455-8965  
● DETROIT OFFICE  
Phone:+1-248-858-9330 Fax:+1-248-858-9455  
● TORONTO OFFICE  
Phone:+1-905-820-7800 Fax:+1-905-820-7811

#### SOUTH AMERICA

THK Brasil LTDA  
Phone:+55-11-3767-0100 Fax:+55-11-3767-0101

#### EUROPE

THK GmbH  
● EUROPEAN HEADQUARTERS  
Phone:+49-2102-7425-555 Fax:+49-2102-7425-556  
● DÜSSELDORF OFFICE  
Phone:+49-2102-7425-0 Fax:+49-2102-7425-299

● FRANKFURT OFFICE  
Phone:+49-2102-7425-650 Fax:+49-2102-7425-699  
● STUTTGART OFFICE  
Phone:+49-7150-9199-0 Fax:+49-7150-9199-888  
● MÜNCHEN OFFICE  
Phone:+49-8937-0616-0 Fax:+49-8937-0616-26  
● U.K. OFFICE  
Phone:+44-1908-30-3050 Fax:+44-1908-30-3070  
● ITALY MILANO OFFICE  
Phone:+39-039-284-2079 Fax:+39-039-284-2527  
● ITALY BOLOGNA OFFICE  
Phone:+39-051-641-2211 Fax:+39-051-641-2230  
● SWEDEN OFFICE  
Phone:+46-8-445-7630 Fax:+46-8-445-7639  
● AUSTRIA OFFICE  
Phone:+43-7229-51400 Fax:+43-7229-51400-79  
● SPAIN OFFICE  
Phone:+34-93-652-5740 Fax:+34-93-652-5746  
● TURKEY OFFICE  
Phone:+90-216-362-4050 Fax:+90-216-569-7150  
● PRAGUE OFFICE  
Phone:+420-2-41025-100 Fax:+420-2-41025-199  
● MOSCOW OFFICE  
Phone:+7-495-649-80-47 Fax:+7-495-649-80-44  
THK Europe B.V.  
● EINDHOVEN OFFICE  
Phone:+31-040-290-9500 Fax:+31-040-290-9599  
THK France S.A.S.  
Phone:+33-4-3749-1400 Fax:+33-4-3749-1401

#### CHINA

THK (CHINA) CO.,LTD.  
● HEADQUARTERS  
Phone:+86-411-8733-7111 Fax:+86-411-8733-7000  
● SHANGHAI OFFICE  
Phone:+86-21-6219-3000 Fax:+86-21-6219-9890  
● BEIJING OFFICE  
Phone:+86-10-8441-7277 Fax:+86-10-6590-3557  
● CHENGDU OFFICE  
Phone:+86-28-8526-8025 Fax:+86-28-8525-6357  
● GUANGZHOU OFFICE  
Phone:+86-20-8523-8418 Fax:+86-20-3801-0456  
THK (SHANGHAI) CO.,LTD.  
Phone:+86-21-6275-5280 Fax:+86-21-6219-9890

#### TAIWAN

THK TAIWAN CO.,LTD.  
● TAIPEI HEAD OFFICE  
Phone:+886-2-2888-3818 Fax:+886-2-2888-3819  
● TAICHUNG OFFICE  
Phone:+886-4-2359-1505 Fax:+886-4-2359-1506  
● TAINAN OFFICE  
Phone:+886-6-289-7668 Fax:+886-6-289-7669

#### KOREA

SEOUL REPRESENTATIVE OFFICE  
Phone:+82-2-3468-4351 Fax:+82-2-3468-4353

#### SINGAPORE

THK LM SYSTEM Pte. Ltd.  
Phone:+65-6884-5500 Fax:+65-6884-5550

#### INDIA

BANGALORE REPRESENTATIVE OFFICE  
Phone:+91-80-2330-1524 Fax:+91-80-2314-8226